



**Installation and Operation Manual
for Perenio® PEIRC01
Indoor Motor Camera**

Introduction

Perenio[®] Cameras are specially designed for indoor monitoring. They are used as part of the **Perenio Smart Building Management System** for the purpose of video surveillance and recording.

Such Cameras allow Users to control and hear everything happening in the area of interest. A high-quality (Full HD) video can be maintained under poor lighting conditions which makes sense for video recording and imaging at night.

The present Manual contains a detailed description of the device, as well as instructions for its installation and operation.

Copyrights

Copyright of ©Perenio IoT spol s r.o. All rights reserved.

The **Perenio**[®] trademark is owned by *Perenio IoT spol s r.o.* (hereinafter referred to as the *Perenio IoT*). All other similar trademarks and names, as well as logos and other symbols are the property of their respective owners*.

All materials under **Perenio**[®] tradename contained therein are protected in accordance with international and local laws including Acts on copyrights and related rights.

Any reproduction, copying, publication, as well as further distribution or public display of materials contained in the present document (whether in full or in part) shall not be allowed until an appropriate permission of the copyright owner is obtained. Any unauthorized usage of materials contained herein may lead to civil liability and criminal prosecution in accordance with applicable laws.

Any eventual mentioning of other company names and equipment in the present document is made solely for the purpose of clarifying and describing the device operation and shall not infringe on the third party's intellectual property rights.

***ZIGBEE** is the registered trademark of *ZigBee Alliance*; **IOS** is the registered trademark of *CISCO TECHNOLOGY, INC.*; **Android** is the registered trademark of *Google Inc.*; **Google Play** is the trademark of *Google Inc.*; **App Store** is the registered trademark of *Apple Inc.*; **Linux** is the registered trademark of *Linus Torvalds*.

Responsibility and Technical Support

The present document is prepared in accordance with all necessary requirements and contains detailed information on the device installation, configuration and control valid as of the date of its issue.

Perenio IoT reserves the right to modify the device and make corrections or changes to this document without prior notice of the User, and shall not be responsible for any potential negative consequences which may arise from the use of an outdated version of the document, as well as for any possible technical and/or typographical errors, either omitted or accidental, or any related damage that may result from the document transfer or the use of devices.

Perenio IoT shall make no guarantee with respect to any data contained herein including but not limited to the device merchantability and fitness for a particular purpose.

In case of any discrepancies between language versions of this document, the Russian version of this User Manual shall prevail.

For any technical issues, please contact your local *Perenio IoT* representative or the Tech Support Department at **perenio.com**.

The most common problems may be found in Section 7 of the present document and at **perenio.com** where you can also download the latest version of this Installation and Operation Manual.

Manufacturer:

Perenio IoT spol s r.o.

Na Dlouhem 79, Ricany – Jazlovice 251 01, Czech Republic

perenio.com

Conformance to Standards



The device is CE certified and complies with requirements of the following Directives of the European Union:

- 2014/53/EU Radio Equipment Directive (RED);
- 2014/35/EU Low Voltage Directive;
- 2004/30/EC Electromagnetic Compatibility Directive.



The device complies with the UKCA marking requirements for selling the device in the UK



The device has passed all procedures of assessments established in Technical Regulations of the Customs Union and conforms with standards of the Customs Union



The device complies with the requirements of Restriction of the Use of Certain Hazardous Substances in Electronic and Electrical Equipment (2011/65/EU Directive)



The device complies with requirements of the Technical Regulations of the Republic of Belarus TR 2018/024/BY (Telecommunications. Security)



The external power source complies with STB 2463-2020 where requirements for the environmental design of external power sources in the area of average effective efficiency and power consumption in idle mode are established



The national conformity mark of the Ukraine indicating that the device meets requirements of all applicable technical regulations



The crossed-out trash can symbol is used to label electrical and electronic equipment, and indicates its separate collection.

The symbol is given in accordance with the Directive 2012/19/EU on Waste Electrical and Electronic Equipment (WEEE)* and indicates that this equipment requires separate collection at the end of its life and must be disposed of separately from unsorted household waste.

To protect the environment and human health, please dispose of used electrical and electronic equipment according to approved safe disposal guidelines



Details on available Certificates are specified in Section 6 of the present document. For copies of Certificates and Reports, please visit a corresponding Section at **perenio.com**.

BG	CZ	DE	ES	FR
GR	IT	KZ	LT	LV
NL	NO	PL	RO	RU
SE	SK	TR	UA	UK

Table of Contents

Introduction	3
Copyrights	3
Responsibility and Technical Support.....	4
Conformance to Standards.....	5
Table of Contents.....	7
1 General Description and Specifications	9
1.1 General Purpose	9
1.2 Technical Specification	12
1.3 Scope of Delivery.....	15
1.4 Packaging and Labelling	16
1.5 Safe Operation Rules	16
1.6 The Use of Power Adapters	17
2 Installation and Setup.....	20
2.1 First Installation and Configuration	21
2.2 Camera Control Panel	28
2.2.1 Armed Mode	29
2.2.2 Event History.....	30
2.2.3 Presets.....	30
2.2.4 Viewing Saved Videos.....	31
2.2.5 Additional Settings	32
2.2.6 Subscriptions.....	34
2.3 Upgrading the Camera Firmware	36
2.4 Reset to Factory Settings.....	36
2.5 Camera Rotation.....	37
2.6 Ethernet Connection	37
2.7 Wi-Fi Router Frequency Settings	37
2.8 The Use of MicroSD.....	38
2.9 Using the Camera Mic	39
2.10 Changing the Room or Location for Cameras.....	39

2.11 History and Push-Notifications	40
3 Maintenance and Repair	41
4 Warranty Obligations	42
5 Storage, Transportation and Disposal of Devices	45
6 Other Information.....	46
7 Troubleshooting.....	47
8 Glossary	48

Figures and Tables

Figure 1 – Front View.....	10
Figure 2 – Back View	10
Figure 3 – Viewing Angles	14
Figure 4 – Pan/Tilt Angles.....	15
Figure 5 – Scope of Supply	15
Figure 6 - Examples of Installation	20
Figure 7 – Mounting holes at the bottom of the Camera.....	22
Figure 8 – Add new device procedure (The Camera activation process)	27
Table 1 – Basic Technical Specifications	12
Table 2 – Types of connectors and USB Standards	18
Table 3 – Buttons and icons of the Camera Control Panel	28
Table 4 – Buttons and icons of the “Recordings” tab.....	31
Table 5 – Available subscriptions.....	35
Table 6 – Typical Errors and Troubleshooting Methods.....	47

Connection to the Perenio Smart Mobile App

A. INSTALLATION OF THE PERENIO SMART MOBILE APP.....	22
B. DEVICE ACTIVATION BY QR CODE SCANNING	24
C. SENDING WI-FI NETWORK DATA TO THE DEVICE.....	25
D. LOCATION AND ROOM SETTING	26

1 General Description and Specifications

1.1 General Purpose

The **Perenio[®] PEIRC01** Indoor Motor Camera is specially designed for indoor monitoring purposes. It can be used both as an independent device and as a part of the **Perenio Smart Building Management System**, when various scenarios for device interaction are activated. A special port allows you to connect external signaling devices, while the HiSilicon Processor ensures high purity of colored images throughout the day.

Key features of the Indoor Motor Camera are as follows:

- High resolution video: Full HD 1080p, 2Mp;
- Wider viewing angle: 90°;
- Remote pan/tilt function: 350°/120°;
- iOS (12.1 and higher) and Android (5.0 and higher) smartphone compatibility;
- Wi-Fi connection;
- MicroSD Card slot (up to 64GB);
- Real-time video recording;
- Setting up of an automatic video recording;
- Built-in IR-filter and a Night Vision mode;
- Increased visibility at night time;
- Motion detection function;
- Arm/Disarm mode;
- Alarms and Push-notifications.

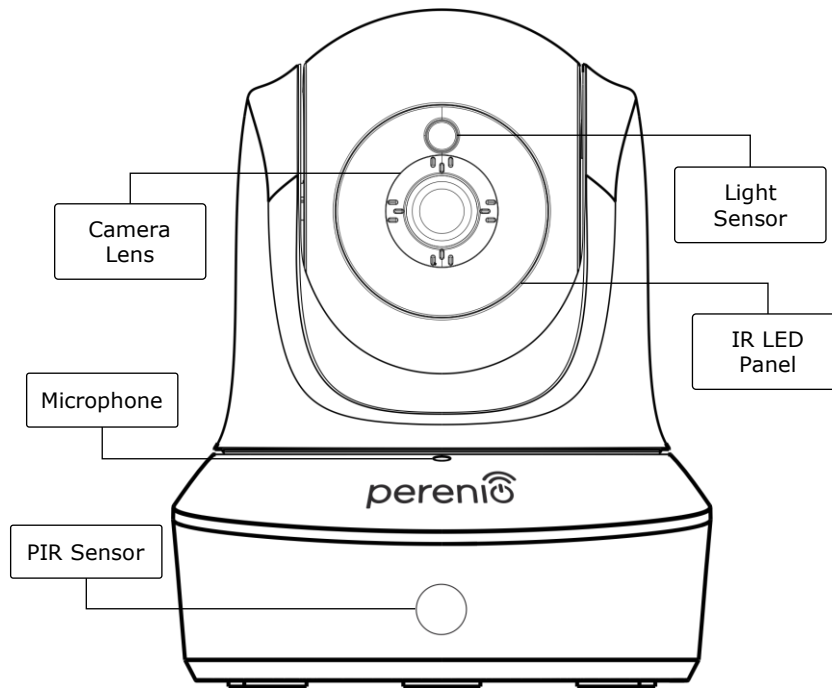

Figure 1 – Front View

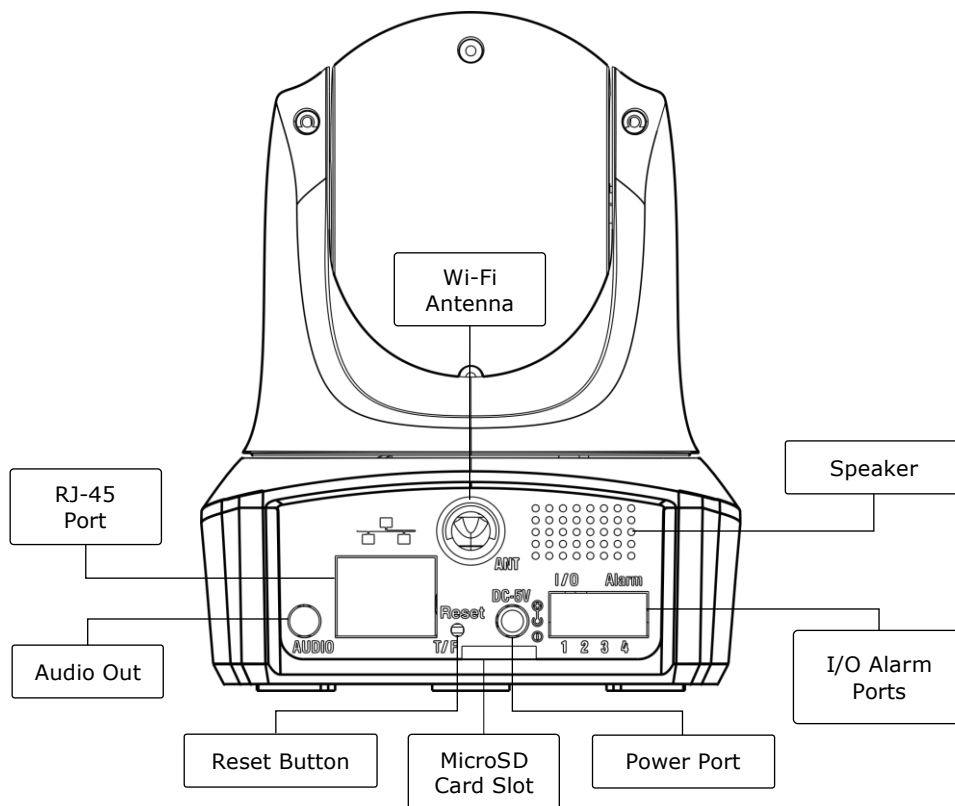

Figure 2 – Back View

Buttons, Ports and Indicators

Camera Lens	It forms an image of the monitored area
Microphone	It allows the User to hear sounds in the monitored area
PIR Sensor	A passive infrared sensor with a pyroelectric element sensitive to changes in heat emission, which provides high accuracy of motion detection
Light Sensor	It determines the level of illumination of the room and disables the IR filter during the period of darkness to maintain the video stream quality
IR LED Panel	The panel containing of eleven (11) infrared LEDs activated in the case of insufficient level of illumination which allows the User to get a high-quality image even in the dark
Wi-Fi Antenna	It is used to receive and transmit wireless Internet signals
RJ-45 Port	The cable port used for connection of the Camera to the Ethernet router (<u>This function is currently unavailable</u>)
Audio Out	An additional port for the Mini-Jack connector aimed at audio reproduction through an external audio device
Reset Button	It is used to reset the device to factory settings
MicroSD Card Slot	The slot for an SD Card generally intended to store video recorded by the Camera
Power Port	The port for connecting the Camera to the mains
Speaker	It allows the User to send voice messages and thus communicate with people and pets in the area of monitoring
I/O Alarm Ports	It is used to connect external sensors to the Camera (<u>This function is currently unavailable</u>)

ATTENTION! All Products and the Mobile Application of the Company (including any future software and hardware whether in-house or third-party developed) are not intended for emergency responses and cannot be used as fire-extinguishing equipment and/or for emergency intervention, including but not limited to fires, flooding, gas leaks or explosions, burglary and theft, as well as natural disasters and other force majeure circumstances leading to damage and/or losses incurred by the Client or caused to their estates, personal property and/or other products, devices, personal data and privacy.

1.2 Technical Specification

Table 1 – Basic Technical Specifications

Parameter	Value
Article	PEIRC01
Processor	HiSilicon Hi3518E V200
Operating System	Embedded Linux
Onboard Memory Chips	Flash (PN): 25Q128FVSG DDR (PN): Built-in EPROM(PN): AT88SC0104CA
Compatibility	iOS (12.1 and higher) and Android (5.0 and higher)
Communication Technology	Wi-Fi (EEE 802.11b/g/n)
Operating Frequency	2.4GHz
Bit Rate	802.11b (11 Mbps max), 802.11g (54 Mbps max), 802.11n (300 Mbps max)
WEP/WPA2 Encryption	Support of 64-/128-bit encryption
Image Sensor	Part Number: GC2033 (GalaxyCore) Type: 1/2.7" CMOS, color Lens: Board Image Size: 1920x1080 Scanning: Progressive Focal Length: 3.6 mm Min Illumination: 0.5 lux Aperture: Fixed Resolution: 2MP
Lens Type	Glass
Horizontal/Vertical Viewing Angle	90°/47° (See Figure 3 below)
Pan/Tilt (Remote)	350°/120° (See Figure 4 below)
Mechanical Pan/Tilt	N/A
Server	P2P
Audio Compression Algorithm	G.726/G.711 (G.711 by default)

Parameter	Value
Video Compression Standard	H.264
Video Resolution	Main Stream: 1920x1080 (Full HD) Sub-Stream: 640x480 (VGA)
Frame Rate	up to 30 fps (For 74.25Hz)
WDR Technology	Available
Video Recording Format	AVI
Audio Recording Format	WAV
Wi-Fi Chip	MT7601UN
Wi-Fi Antenna	Type: Standalone Operating Frequency: 2.4GHz (14-channel) Transmitting Power: 14dBm to 17dBm Receiver Sensitivity: -92dBm до -68dBm Antenna Gain: 2dBi
Zigbee Antenna	N/A
Support of SD Cards	Slot for MicroSD (up to 64GB) Recommended Speed Class: Class 10 (Recording speed of not less than 10MByte/s) Recommended Capacity: 32GB to 64GB Format: FAT32
Mic	Built-in
Speaker	Built-in (<u>Currently, not used</u>)
IR Filter	Built-in
RJ-45 Port	Available (<u>Currently, not used</u>)
Additional Outputs	AUX OUT
External Sensor Connection	4 I/O Alarm ports (<u>Currently, external sensors are not connected to this device</u>)
PIR Sensor	Detection Angle: 90° Detection Distance: 7 meters
Night Mode	11 IR LEDs, vision of up to 15 meters Peak Wave Length: 850 nm

Parameter	Value
Power	Voltage: 5VDC Current: 2.0A Power Consumption: 5W (max)
Operating Temperature	0°C to +55°C (32°F~131°F)
Operating Humidity	20% to 85% (non-condensing)
Storage Temperature	-10°C to +60°C (14°F ~140°F)
Storage Humidity	0% to 90% (non-condensing)
Installation	On horizontal or vertical surface (Mounting holes available). For indoor installation only.
Casing Material	ABS/PMMA
Color	White
Dimensions (L x W x H)	90 mm x 112 mm x 112 mm
Weight	278 g
Warranty Period	24 months
Service Life	24 months
Certification	CE, EAC, RoHS, UA.TR
Data Protection	GDPR Compliance

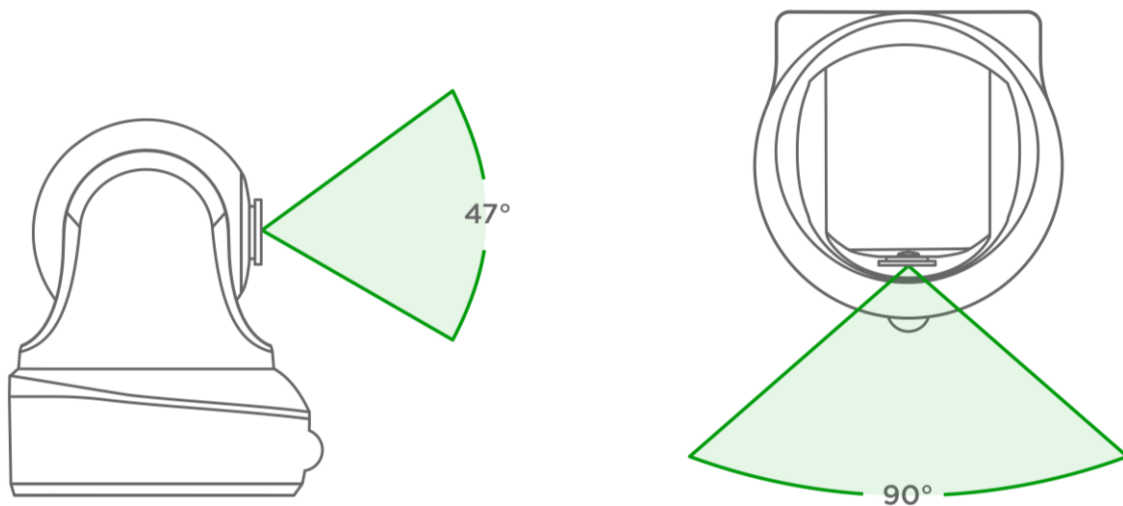

Figure 3 – Viewing Angles

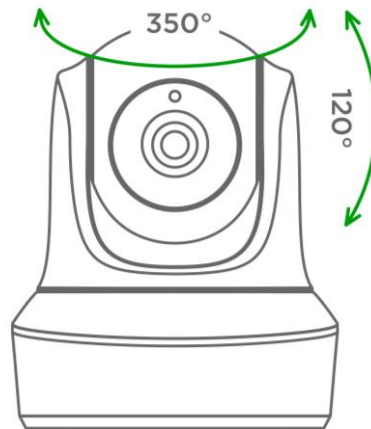

Figure 4 – Pan/Tilt Angles

1.3 Scope of Delivery

The following items and accessories are supplied within the **PEIRC01** Indoor Motor Camera package:

1. PEIRC01 Indoor Motor Camera (1 pc.)
2. Ethernet Cable (Length: 1.5 m) (1 pc.)
3. Power Adapter (Output: 5V, 2500mA, length: 1.5m) (1 pc.)
4. Quick Start Guide (1 pc.)
5. Warranty Card (1 pc.)
6. Stickers (2 pcs.)



1



2



3

Figure 5 – Scope of Supply*

* Images of accessories are provided for informational purposes only

1.4 Packaging and Labelling

The **Perenio® PEIRC01** Motor Camera is supplied in a carton Gift Box of 201mm x 136mm x 97mm (L x W x H) containing the full name and marking of the device, the list of accessories provided and basic technical specifications thereof, as well as the date of manufacture and information about the Manufacturer of devices.

Carton package weight:

- Net Weight: 278g;
- Gross Weight: 661g.

1.5 Safe Operation Rules

For the proper and safe operation of **Perenio® PEIRC01** Indoor Motor Cameras, follow the instructions and safety procedures described in the present Manual. The Manufacturer shall not be liable for any damage caused as a result of improper operation of devices.

Safe Operation Conditions

1. The device shall be installed indoors only.
2. The User shall not try to pan/tilt the Camera head manually.
3. The User shall observe storage/transportation conditions, as well as the operating temperature mode of the device as declared by the Manufacturer.
4. The User shall not install the device in the area with high humidity and high content of dust and/or grease, as well as in the immediate vicinity of air conditioners and ceiling fans.
5. The User must not disassemble or attempt to repair the device on their own.
6. The User must not drop, throw or bend the device.
7. In order to avoid personal injury, it shall not be allowed to use the cracked or in any other way damaged device.
8. Use dry cloth or cloth soaked in a small amount of water for cleaning (don't use harsh chemicals/cleaning agents). The device must be powered off before cleaning.
9. Children shall not be allowed to use the device unsupervised and/or play with it.

1.6 The Use of Power Adapters

Only the original power adapter included in the delivery package, or some other adapter recommended by *Perenio IoT* shall be used to power or charge the device. This is due to the fact that an incompatible power adapter can cause longer charging time, or a device failure, or a fire, whereas the original power adapter considers all the mandatory technical parameters, namely:

- a. **Voltage** the power supply output (See "OUTPUT, V" parameters on the adapter body);

ATTENTION! The output voltage of the power adapter must strictly correspond to the voltage consumed by the main device.

- b. **Current** at the power supply output (See "OUTPUT, A/mA" on the adaptor body);

NOTE. The current delivered by the power adapter must be equal to or slightly higher than the rated current for the main device.

- c. **Polarity** on the connector (pin) of the power adapter;

NOTE. The polarity indicates the part (external or internal) of the connector that receives positive current.

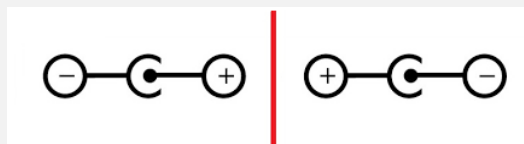

The dot in the above image represents the connector's inner contact, and the crescent moon represents the outer contact. Most connectors have two contacts. One contact carries a voltage ("+"), while the other - zero ("-").

ATTENTION! The poles must not be interchanged.

Some devices are charged by or run on an AC power adapter. In this case, the adapter has no indication of the polarity, and the AC "~" symbol is shown next to the indicated output voltage.

- d. **Configuration** and size of the power adapter cable connector;

NOTE. Geometric shape, outer/inner diameter size and length of the power adapter cable connector must match the parameters of the power port connector of the main device.

Power adapters supplied by *Perenio IoT* with the devices have one of the following types of cable connectors:

1. Standard cylindrical shaped connectors for powering the Indoor Motor Camera and the Control Gateway.
2. USB connectors for powering the Indoor Fixed Camera, the IoT Router and the Ion Diffuser (MicroUSB, Type-C).

There are also devices that are supplied only with a cable (without a power adapter), such as Red Atom device and UV Mini Indigo lamp). Power cables for such devices are also equipped with the second type of the connector.

Table 2 – Types of connectors and USB Standards

Standard	Parameters	Description
USB1.0	5V, up to 150mA 0.75W DTS*: 12Mbps	Obsolete standard of information exchange and connection methods (not used due to too low data transfer rate)
USB2.0	5V, up to 500mA 2.5W DTS*: 480Mbps	Suitable for devices with low power consumption, but data can only be transmitted in one direction at a time
USB3.0	5V, up to 900mA 4.5W DTS*: 5Gbps	It supports backward compatibility with the old standard. It has the same shape as USB2.0 Type-A, but colored blue. Data can be transmitted in both directions at the same time
USB Type-C (without PD**)	Up to 5V, up to 3A 15W DTS*: 10Gbps	This is an oval shaped connector with reversible key. It can be used for data transfer of the USB3.1 interface
USB-PD	Up to 20V, up to 5A 100W DTS*: 10Gbps	This is a USB Type-C with a power transfer function up to 100W. This option is suitable for powerful devices (laptops, large tablets), but may not be suitable for less powerful devices.

Standard	Parameters	Description
		Therefore, it is not used with Perenio[®] devices

* DTS means data transfer speed

**PD means Power Delivery protocol

NOTE. USB Type-C is not USB3.1, because USB2.0, USB 3.0 or USB3.1 can be used to supply power. On the other hand, USB Type-C is not USB Power Delivery and does not necessarily support USB Power Delivery or USB3.1.

ATTENTION! Currently, *Perenio IoT* **does not supply** power adapters with connectors that support USB-PD.

ATTENTION! Do not connect a USB-PD compatible power adapter (Power Delivery fast charging standard) to the device. It is also not permitted to use the charger to power or recharge incompatible devices (For more information on the charger, see the technical specifications).

The manufacturer shall not be liable for any consequences, whether direct or indirect, arising from the use of the power adapter for purposes other than its intended use, or to supply power or charge the device not included in the scope of delivery.

As the power adapter cable connectors are subjected to daily stress, they can become damaged over time. Below see basic signs of a faulty charger connector:

- Unreasonable switching off of the device;
- Unreasonable switching of the device to the battery mode;
- Overheating of the USB plug;
- Periodical switching off of the device in the absence of the mains failure;
- Start of the charging process only after the cable is additionally fixed, or the plug is reconnected;
- No battery charging process when the power adapter is connected.

ATTENTION! Do not charge your device from external devices such as PC, laptop, tablet or smartphone if the maximum current of 500mA/900mA (USB2.0 and USB3.0 ports, respectively) is insufficient to provide the required power input level to the device.

2 Installation and Setup

Before installation, the User shall select one of the following possible locations and mounting modes for the device:

- On a horizontal surface (the floor, a table, a stand, etc.);
- On a vertical surface (walls, furniture, etc.).

Also, make sure that the selected location meets the following requirements:

- No clutter and obstructions in the Camera viewing angle area;
- Flat and stable surface, as well as the mains socket near the installation site of the Camera and/or mounting brackets.



Figure 6 - Examples of Installation*

** Images of accessories are provided for informational purposes only*

NOTE. It is not recommended to install the device in areas with a high level of noise and a high-frequency interference. Reinforced concrete floors may reduce distance of wireless signal transmission. The Camera installation site shall protect it from contact with moisture and foreign objects.

The entire setting-up process can be divided into several key steps as follows:

- Installation of the Camera in the selected location and connection to the source of power;
- Logging in to the **Perenio Smart** User Account;
- Activation of the Camera via the Mobile App.

NOTE. The *Perenio Smart: Building Management System Mobile App Manual* document is available for downloading at the web-site.

2.1 First Installation and Configuration

To ensure proper installation and operation of the Camera, it is necessary to perform the following steps:

1. Unpack the Indoor Motor Camera and connect it to the power source (220V) using the Power Adapter.
2. Log in to the **Perenio Smart Building Management System** mobile application on your smartphone (See par. **A** below).
3. Activate the device in the mobile app (See pars. **B** and **C**, as well as par. 2.7 for network frequency selection).
4. Enter the desired Camera name, Location and Room.
5. Install the device on a flat horizontal surface, or mount using screws (Screws and dowels are not included in the scope of delivery). See Figure 7 below.

ATTENTION! The required viewing angle of the Camera shall be considered during installation.

6. Wait for firmware update process to be completed (See par. 2.3).

ATTENTION! Camera firmware update process may be started upon its initial activation in the mobile application. **It is not allowed to power off the device after the firmware update process is started!**

The Device must not be switched off or disconnected from the mains for at least **5 minutes** after the RESET Button is pressed.

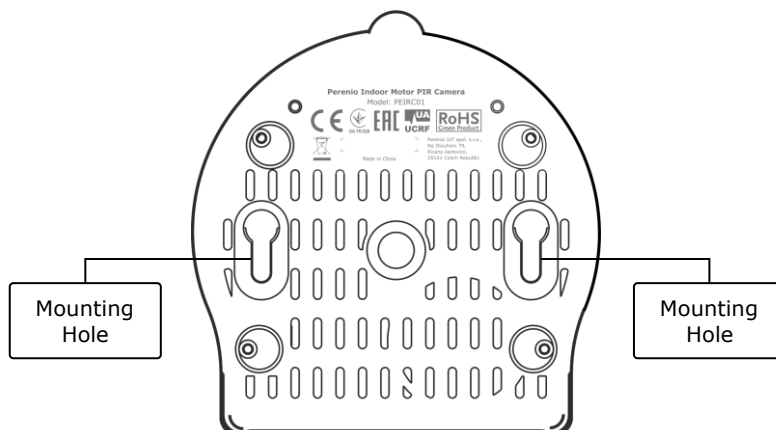
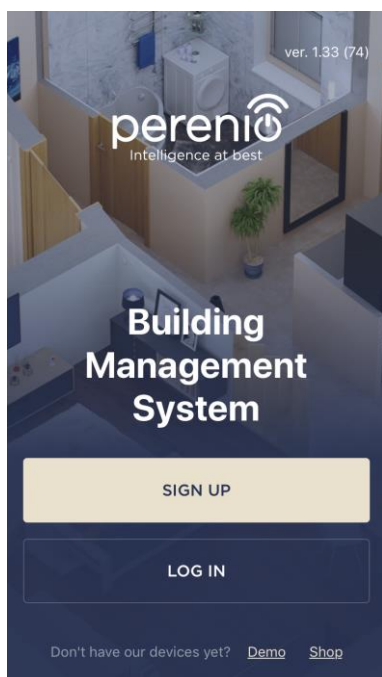

Figure 7 – Mounting holes at the bottom of the Camera

A. INSTALLATION OF THE PERENIO SMART MOBILE APP



The Camera shall be managed through a free mobile application available for downloading in Google Play or App Store.

In order to log in to the User Account, follow the steps below:

- a.** Connect your smartphone to the Wi-Fi Network and download the **Perenio Smart Building Management System** app from Google Play or App Store;
- b.** Register a new User Account (See par. **A.1.** below) or sign in to an existing User Account (See par. **A.2.** below).

A.1. NEW USER ACCOUNT REGISTRATION

- a. Fill in your e-mail address, user name and password (8 or more symbols including at least one capital letter and one number), then select the country of residence;
- b. Agree to General Terms and Conditions, Privacy Policy and provisions for personal data protection (accessible by the link);
- c. Click on the **SIGN UP** button.
The User will receive an email to verify the User Account (Follow the link);
- d. Log in to the User Account.

← Sign up

Email
john.smith@gmail.com

User name (optional)
John

Password
•••••••• show

At least 8 characters • 1 uppercase letter •
1 lowercase letter • 1 number •

Country
United Kingdom

[Why should I provide my country of residence?](#)

Remember my password
Upon subsequent login, the user will be logged in automatically

I agree to the [Terms and Conditions](#), [Privacy Policy](#) and [GDPR Compliance](#)

SIGN UP

A.2. LOGGING IN TO THE EXISTING USER ACCOUNT

← LOG IN

john.smith@gmail.com

•••••••• show

Remember my password
Upon subsequent login, the user will be logged in automatically

LOG IN

[Forgot password](#)

- a. Enter your e-mail address and password in the login screen.
- b. Click on the **LOG IN** button.

NOTE. If the password is lost, the User can restore it by clicking on a corresponding link on the screen.

To restore a forgotten password, use the e-mail address linked to your User Account, as instructions on changing the password will be sent thereto.

B. DEVICE ACTIVATION BY QR CODE SCANNING

- a. Switch to the QR Scan screen as follows:
- **For new Users:** The QR Scan screen will be displayed immediately after the first login to the Perenio Smart App User Account;
 - **For existing Users:** After login to the Perenio Smart App User Account, click on the "+" icon in the upper right corner of the Devices tab and then the Motor Camera device in the list (See Figure 8).
- b. Click on the **SCAN QR CODE** button;
- c. Confirm the permission to access your Camera in the pop-up window (It may not be available for certain smartphone models);

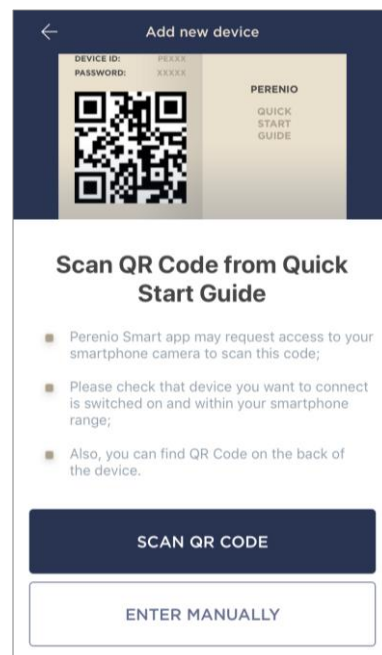

- d. Find the QR Code sticker on the back of the Quick Start Guide supplied with the Camera or on the bottom of the Camera and place your smartphone 15-20 cm away from it, so that the QR Code is completely visible on the smartphone screen (See the picture on the left).

NOTE. In the event that the QR Code can't be scanned, you may activate the device manually (see par. **B.1.** below).

B.1. MANUAL ACTIVATION OF THE DEVICE

If the QR Code was damaged or lost, you can enter the device data manually as follows:

- a. Click on the **ENTER MANUALLY** button at the bottom of the QR Code scan screen (See the figure in par. **B**);
- b. Enter the Device ID and the Password specified in the Quick Start Guide or on the bottom of the device (ID and Password lines next to the QR Code);
- c. Click on the **CONNECT** button.

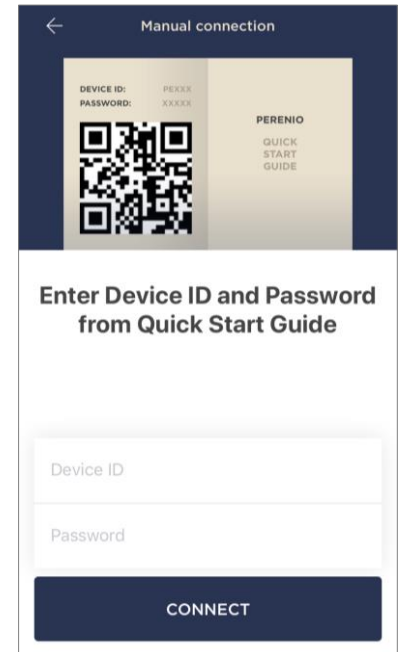

C. SENDING WI-FI NETWORK DATA TO THE DEVICE

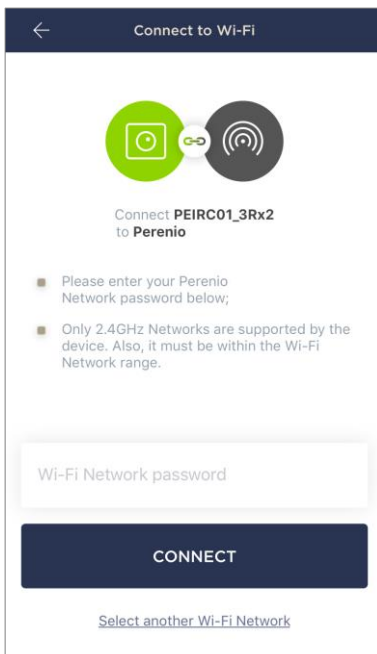

Do as follows after the screen to connect the device to the Wi-Fi Network will be displayed:

- a. Enter the password from the Wi-Fi Network or select another network;

NOTE. The device may be connected to Wi-Fi Network of **2.4GHz** only.

- b. Click on the **CONNECT** button.

NOTE. Before connecting, make sure that the Camera is powered on and that the smartphone is located at a distance of not more than 2 meters from it.

If the Wi-Fi Network password is incorrectly entered more than twice in a row, the Camera may not return to the Access Point mode, which means that the reset to factory settings will be required (See par. 2.4 below).

C.1. CONNECTION ERRORS

The connection failure of the device may occur due to one of the following reasons:

- a. The device is switched off or at a too long distance from the smartphone;
- b. The device was already activated in the current or some other User Account;
- c. The device ID and/or password or Wi-Fi Network data was entered incorrectly;
- d. Internet Provider failures.

NOTE. To eliminate connection failures, follow instructions specified on corresponding screens of the smartphone.

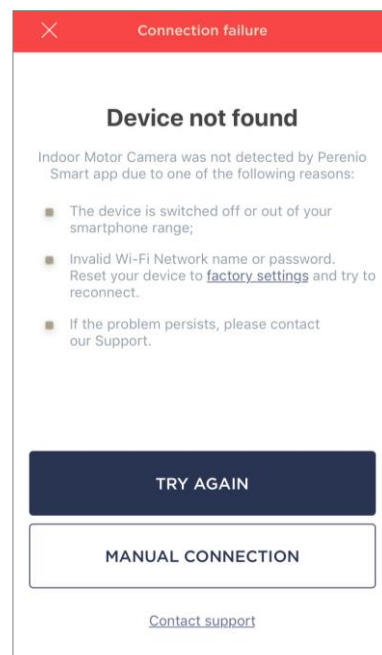

D. LOCATION AND ROOM SETTING

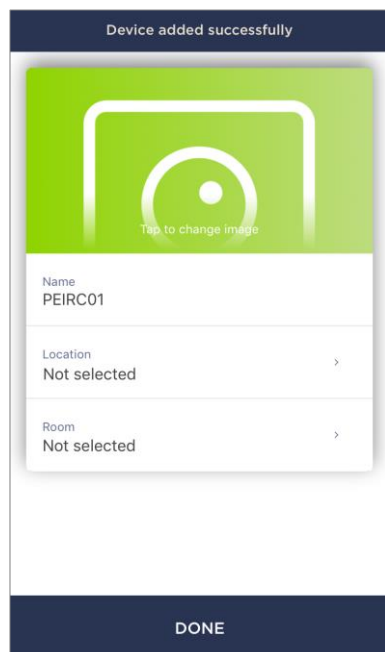

After successful connection of the device, the User may specify the following:

- a. Image;
- b. Device name;
- c. Device Location;
- d. Room.

You can also select an image for the device by clicking on the "Tap to change image" link.

After completion, click on the **DONE** button.

The Camera will be displayed in the Devices tab.

The entire process of the Camera activation in the Mobile App is shown below.

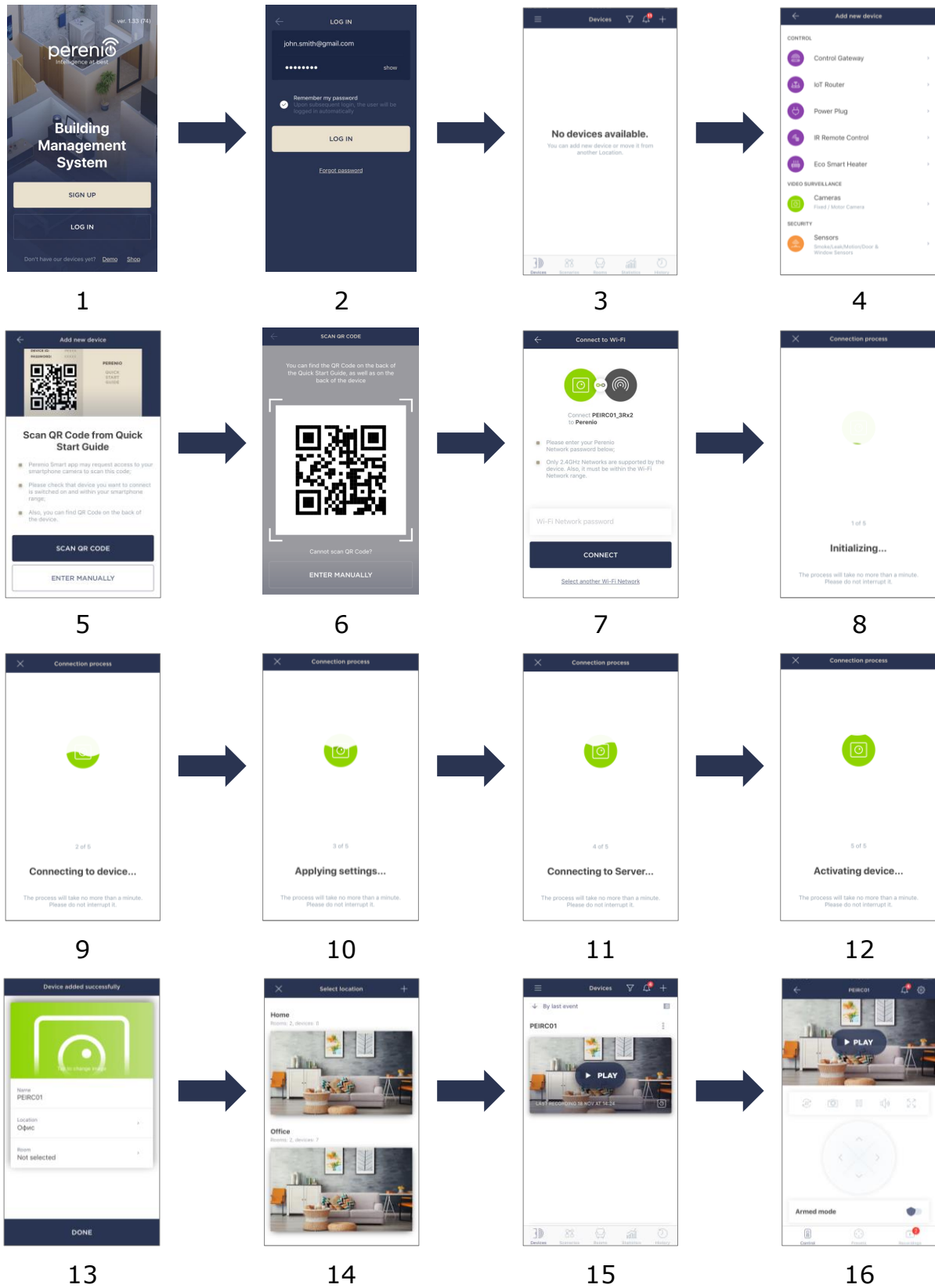
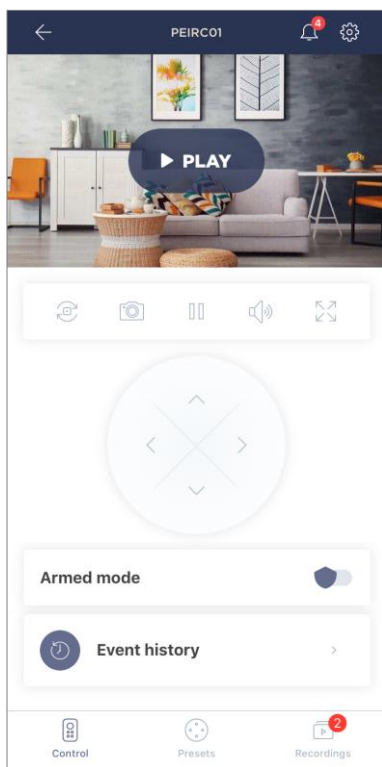

Figure 8 – Add new device procedure (Camera activation process)

2.2 Camera Control Panel



The Camera control panel is displayed, when you click on its image in the list of connected devices in the "Devices" tab.

The user can perform the following actions in this control panel:

- Rotate the Camera head remotely;
- Watch online and saved video;
- Take images from the Camera;
- Arm and Disarm the device;
- View the history of events;
- Add presets;
- Make additional settings.

Table 3 – Buttons and icons of the Camera Control Panel

Icon	Description
	Return to the Devices tab
	The list of unread messages and notifications
	Additional settings of the device
	Rotate the screen 90°
	Take a screenshot from the camera
	Stop video streaming
	Enable/disable camera speaker
	Expand image to full screen
	Virtual joystick to rotate the Camera head

The User can watch videos captured from the Camera in a real time mode. However, when switching to the video viewing screen, it should be remembered that the Camera mic is **enabled by default**. To watch video in a mute mode, you should turn off the speaker by clicking on a corresponding icon (🔇) in the Camera panel.

2.2.1 Armed Mode

The user may Arm the Camera in order to receive push notifications on their smartphone every time motion is detected.

Also, if there is no need to receive push notifications, the Camera can be Disarmed, so that all changes of its state are saved to the "Event History" tab only.

The Armed Mode can be activated and deactivated in two ways as follows:

- Press the corresponding toggle switch in the Camera control panel;

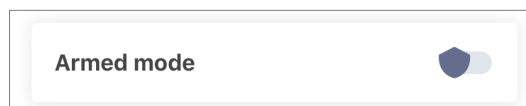

NOTE that in this case, the specified Camera will be Armed only.

- Go to "Device Scenarios" screen and Arm the Location.

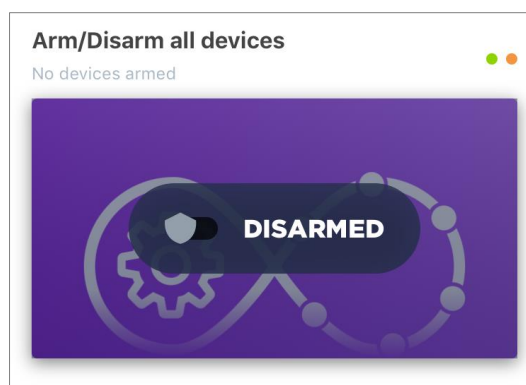

NOTE that in this case, the entire Location will be Armed, i.e. not only the above Camera, but also other devices connected in this Location.

2.2.2 Event History

In this tab, the user can view the status of the device, as well as the time when the event occurred.

Functions are as follows:

- "ENTIRE HISTORY" filter, which allows viewing the following events:
 - Changes in the security modes ("Online", "Offline", "Armed", "Disarmed");
 - Device actuation events ("Motion detected");
 - Start and completion of the firmware update;
 - MicroSD Card being filled in.
- "ALARMS ONLY" filter, which displays device actuation events for the Armed Mode only;
- Filter by date.

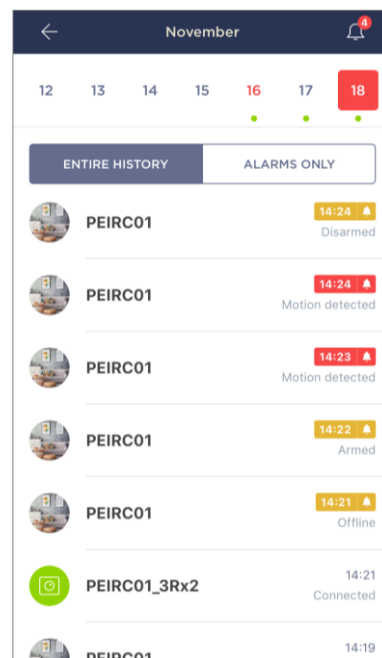

NOTE that the number of days available for viewing depends on the Subscription Plan (It is 7 days for free Subscription).

2.2.3 Presets

A preset is a predefined angle of pan/tilt of the Camera to which it will automatically return after a specified period of time if it was changed by the User.

To create a new preset, please use the virtual joystick to turn the Camera head to the desired position, then click on the corresponding block in the "Presets" tab and set the name of the preset.

NOTE that the active preset will have a "Default" status.

2.2.4 Viewing Saved Videos

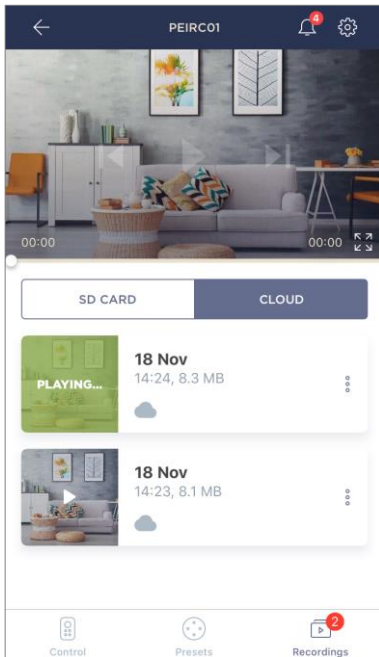

In the “Recordings” tab, videos recorded by the Armed Camera upon motion detection are stored.

There are two video storage locations as follows:

- MicroSD Card;
- Cloud.

NOTES. The period for storage of video files on the MicroSD Card depends on its capacity, while in the cloud – on the type of Subscription (See par. 2.2.6 below).

The duration of one video record is one (1) minute.

It may take some time for the video file to appear in the recordings list after the Camera detects motion.

Table 4 – Buttons and icons of the “Recordings” tab

Icon	Description
	Expand image to full screen
	Take a picture from the camera
	Scroll the video back
	Play video or start live streaming

To view video, the User shall click on its image in the list and wait for the file to be downloaded.

NOTE that recorded videos and photos can also be saved to a smartphone, as well as deleted therefrom by clicking on the three dots icon opposite the video file image.

2.2.5 Additional Settings

After the Camera is activated in the **Perenio Smart** app, the User can make the following settings remotely:

- Change or upload the device image for easier identification of the Camera in the list of connected devices;
- Change the name of the device;
- Move the device in a new or existing Location;
- Add the device to the Room or change the Room of installation;
- Select resolution for images and videos;
- Select the default storage for video files (MicroSD or Cloud);
- Turn on or off the sound of push notifications;
- Set up an alarm delay sent to user's smartphone;
- Restart the device;
- Remove the device from the mobile application;
- View the device ID;
- View the current firmware version of the device.

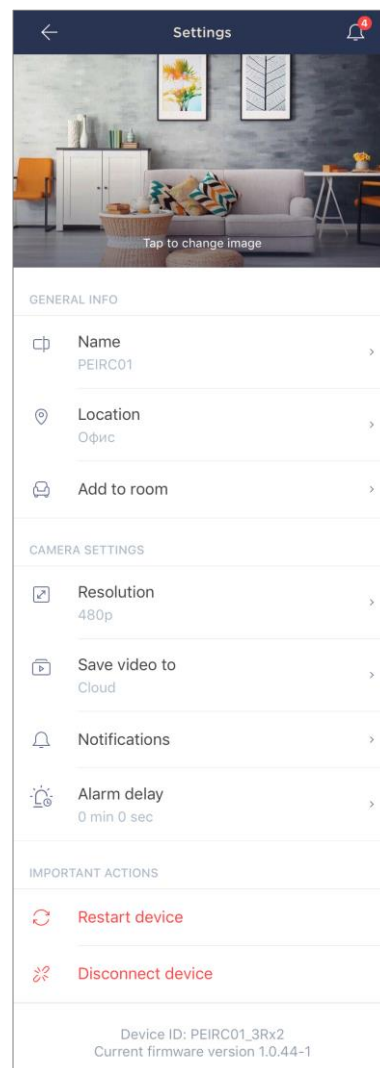

There are two ways to switch to the settings screen, namely:

1. Click on the icon with three dots in the right upper corner of the Camera image in the mobile application and select "Settings".

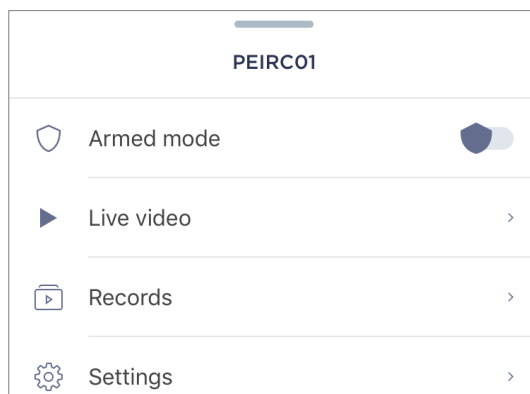

2. In the control panel, click on the settings icon.



Image Resolution

Video records are currently available in the following resolutions:

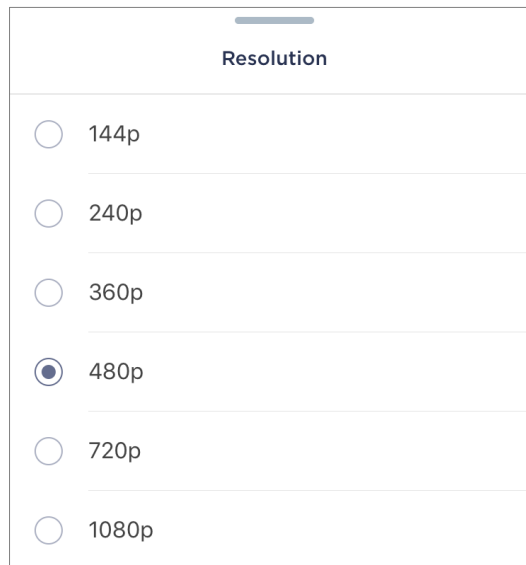

Resolution	
<input type="radio"/>	144p
<input type="radio"/>	240p
<input type="radio"/>	360p
<input checked="" type="radio"/>	480p
<input type="radio"/>	720p
<input type="radio"/>	1080p

NOTE that the higher the resolution is, the less 1-minute video files can be stored on the MicroSD card. Also, video files with a higher resolution will take longer to be processed and saved, so delays are possible for uploading and playing such videos.

Video storage

Currently, recorded videos and images may be stored in one of the following locations:

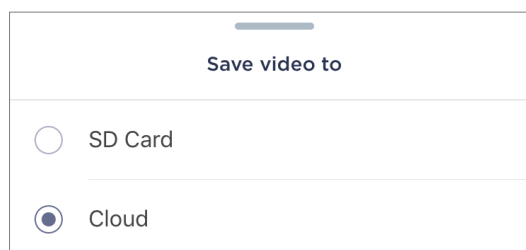

Save video to	
<input type="radio"/>	SD Card
<input checked="" type="radio"/>	Cloud

The period for storage of video files on the MicroSD Card depends on its capacity, while in the cloud – on the type of Subscription.

Alarm Delay

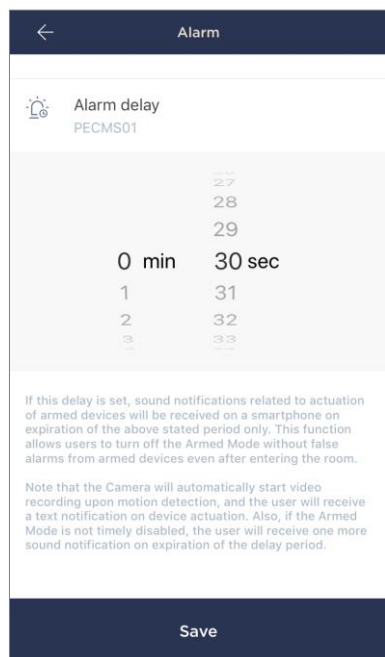

To set the delay period, the User shall click on a corresponding button in the Camera settings screen.

If the alarm delay is set, the sound notification related to the Camera actuation will be received on a smartphone only after a specified period of time.

ATTENTION! The alarm delay can only be set for Cameras that are Armed.

This feature allows users to Disarm devices after entering the premises without receiving false alarms.

2.2.6 Subscriptions

Subscriptions allow the User to increase the storage period of the following information and data in the cloud:

- Videos and images;
- History of events;
- Statistics.

By default, all users of the **“Perenio Smart: Building Management System”** Mobile App are subscribed to a free plan with a limited storage period.

To view and change the current type of Subscription, the User shall go to the Side Menu and click on a corresponding button (See Figure on the right).

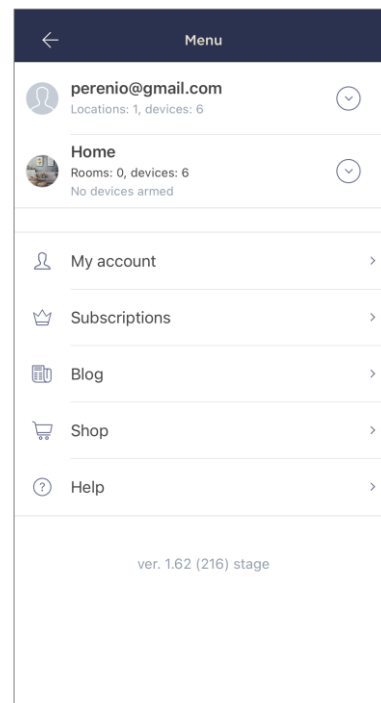

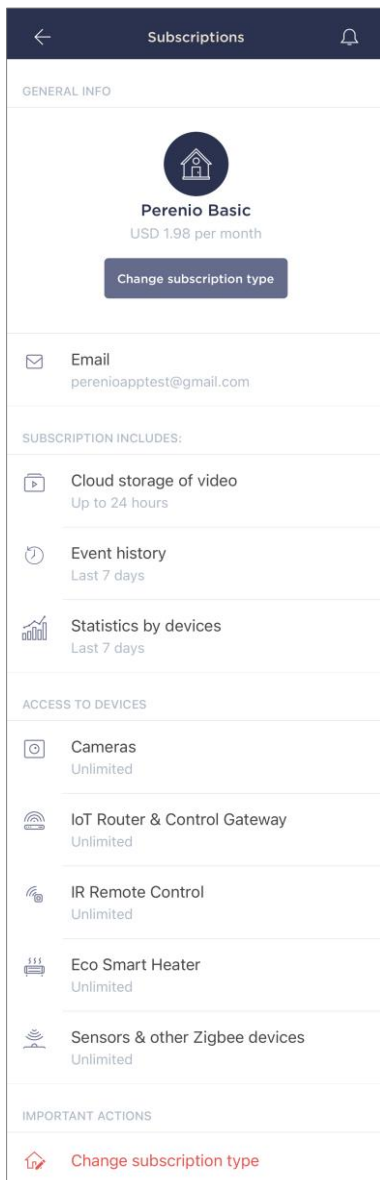

The following details for the current Subscription type will be displayed:

- Subscription name (Perenio Basic, Perenio Pro or Perenio Extra);
- Subscription (monthly) fee;
- Option to change the type of Subscription;
- Information about the Subscriber (Email address);
- Information about data storage in the Cloud;
- Information about the maximum number of devices that may be connected to the User Account.

To change the type of Subscription, the User shall click on a corresponding button and select the desired tariff plan from the list. Then, confirm the choice.

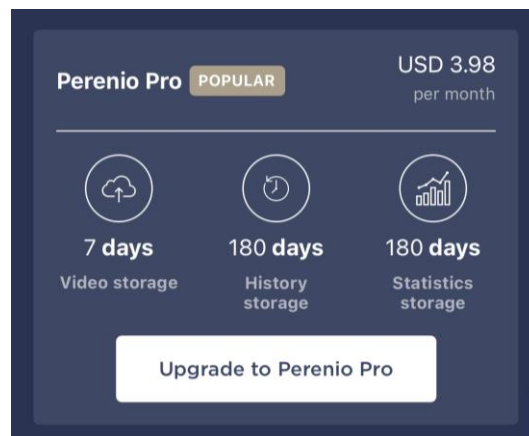
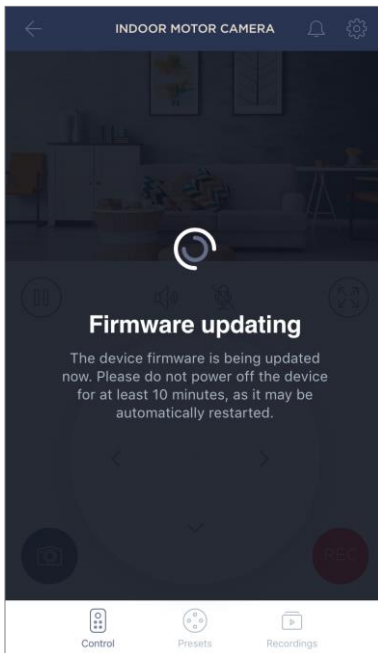

Table 5 – Available subscriptions

Storage	Perenio Basic	Perenio Pro	Perenio Extra
Video	24 hours	14 days	30 days
History	Last 7 days	Last 180 days	Last 365 days
Statistics	Last 7 days	Last 180 days	Last 365 days

2.3 Upgrading the Camera Firmware



Perenio IoT strives to constantly improve the quality of its products, so an automatic software (firmware) update can be launched during the first activation of the Camera, as well as during its normal operation.

In this case, the User will see a corresponding notification in the Camera control panel in his/her User Account.

IMPORTANT! It is not allowed to disconnect the device from the power source for at least **10 minutes** after the firmware update process is started.

During the firmware update process, it will be impossible to view video stream from the Camera. Also, the device may reboot repeatedly.

The User is allowed to disconnect the device and/or perform reset to factory settings only after receiving an appropriate push-notification to the his/her smartphone that the update process is successfully completed, and after the Camera becomes online (The black screen disappears, and the video stream becomes available again).

NOTE that in the event of any power failures during the firmware update process, Camera malfunctions may occur. In this case, you need to contact our Technical Support Service to restore factory settings.

2.4 Reset to Factory Settings

The reset to factory settings of the Camera shall be performed in the case of any errors or connection failures occurred during the activation process of the Device in the Mobile Application. The reset to factory settings procedure shall be performed as follows:

1. Press and hold the Reset button for at least 10 seconds (You can find it on the back of the Camera under the antenna – see Figure 2). **Note that the Reset button is considered to be pressed only if a specific click is heard.**
2. Release the Reset button after the Camera beeps.
3. Wait until the reset process will be finished (The rotary head of the Camera shall stop rotation in all directions and return to its original position).

After completion of the reset process, the Camera is considered ready to be connected or reactivated in the Mobile Application.

NOTE. The reset to factory settings is possible when the Camera is connected to the source of power, and there is no firmware update process.

It is not recommended to perform the factory reset until the Camera is deactivated in the Mobile Application (**Valid for Devices already being activated in the User Account**).

2.5 Camera Rotation

Any rotation relative to the body of the Motor Camera shall be performed using the Mobile Application only. Any attempts to mechanically rotate the Camera head may result in a damage to the propelling mechanism and will void the warranty. To rotate the Camera in the desired direction, click on the virtual joystick in the Camera control panel (Up/Down and Right/Left buttons).

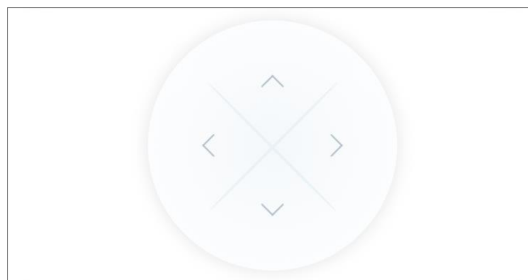

The response of the Camera depends on the quality of the connection to the Server, so in some cases there may be small delays when rotating the Camera.

2.6 Ethernet Connection

Currently, this Camera may be connected to the Internet via Wi-Fi only (Connection via an Ethernet cable is temporary unavailable).

2.7 Wi-Fi Router Frequency Settings

Perenio[®] PEIRC01 Indoor Motor Cameras may be connected to the Wi-Fi Network of 2.4GHz only. Due to this fact, the User shall make sure that your Wi-Fi router is set

to the above frequency before proceeding to par. **C. "SENDING WI-FI NETWORK DATA TO THE DEVICE"**.

Currently, Wi-Fi routers of most manufacturers support both frequencies, but in the case your local Wi-Fi is set to 5GHz only, it is necessary to add the access point of 2.4GHz as well.

NOTE. Your Wi-Fi router frequency settings shall be performed according to instructions of its manufacturer.

2.8 The Use of MicroSD

ATTENTION! In order to ensure stable operation of the video recording function, older files are automatically deleted as the MicroSD card is full (For cases when the card is more than 70% full), therefore it is recommended to periodically save important files to other media or to the cloud.

Images and video files recorded by the Camera can be stored in the MicroSD Card, which is not included in the delivery package of the PEIRC01 Indoor Motor Camera (See paragraph "1.3 Scope of Delivery"). To use a MicroSD Card, you may just purchase it and insert it into a special slot (See Figure 2 "Back View").

NOTE that the recommended class and format, as well as the capacity of the MicroSD Card are specified in Table 1 of this document.

Failure to comply with the manufacturer's requirements for the microSD card format may result in video recording errors.

In the case appropriate settings are made in the Perenio Smart Mobile App, it is possible to automatically save video records in the case of motion detection to the MicroSD Card.

It should be noted that in the case of video and image storage on the MicroSD Card, the number of saved files will depend on its capacity (up to 64GB), as well as on the duration and quality of the recorded video files.

ATTENTION! There is no possibility to view third-party files from the MicroSD Card via the Perenio Smart Mobile App.

2.9 Using the Camera Mic

The User can watch videos captured from the Camera in a real time mode. However, when switching to the video viewing screen, it should be remembered that the Camera mic is **enabled by default**. To watch video in a mute mode, you should turn off the speaker by clicking on a corresponding icon (🔇) in the Camera panel.

2.10 Changing the Room or Location for Cameras

When using the Camera, it may be necessary to change its installation area. The following options are possible:

- 1. Change the room/location** (The Wi-Fi Network remains the same):
 - a. Disconnect the Camera from the mains (The status of the device will be changed to "Offline");
 - b. Move the Camera to another room/location and connect it to the mains;
 - c. Wait until the Camera is rebooted (It usually takes no more than 2 minutes) and the status of the device is changed to "Online";
 - d. Change the Room/Location in Camera settings screen (⚙️).
- 2. Change the room/location** (The Wi-Fi Network will also be changed):
 - a. Sign in to the Perenio Smart app and select the Location where the Camera is activated;
 - b. In the Devices tab, select the required Camera from the list and click on the ⚙️ icon (Settings);
 - c. In the pop-up window, choose "Disconnect device";
 - d. Wait for around **3 minutes** in order for the Camera to disconnect from the current Wi-Fi network;
 - e. Disconnect the Camera from the mains;
 - f. Move the Camera to another room/location and connect it to the mains;
 - g. Wait until the Camera is rebooted (It usually takes no more than 2 minutes);
 - h. In the User Account, select the Location where you want to move the Camera;
 - i. Activate the Camera in the Mobile App according to par. 2.1 "First Installation and Configuration of the Camera" (B-D) of this document.

2.11 History and Push-Notifications

All notifications and other messages including changes in the status of **Perenio®** devices are displayed in the "History" tab. The most important messages can be viewed online in the "🔔" notification window in your account.

The following types of notifications are available:

- (Critical) alarms (They always come as push notifications to your smartphone, and are also displayed in the notification window, as well as in the "History" tab of the mobile app; The indication color is red);
- Important messages (They are always displayed in the notification window and the "History" tab; The indication color is yellow);
- Typical events (They are displayed in the "History" tab only; The indication color is not available).

Alarms. These are the most important messages, which include notifications about the following events:

- IoT Router battery charging is low;
- The IoT Router runs on battery;
- Motion detection by the camera;
- There is not enough space on the SD card to continue recording video;
- Change of the camera status to "Offline";
- Sensor triggering in the armed mode, including all alarms from smoke and leak sensors (even when the Location is in the disarmed mode);
- Disabling the sensor armed mode;
- Failure to perform the scenario;
- Connection of a dangerous device, and overloading the network (for the Power Link Wi-Fi Smart plug);
- Sudden changes or insufficient voltage, excessive power, temperature and/or consumption (for Power Link (ZigBee) Smart plug);
- Falls and/or overheats of the Eco Smart Heater, or sudden changes in voltage;
- Important updates.

Important messages. These are notifications on launches and completion of the camera and the Control Gateway firmware update, as well as notifications about low battery level of the sensor and changing the armed mode for the Location.

Typical Events. Various Perenio IoT newsletters, as well as messages about triggering Door & Window/Motion sensor in the disarmed mode.

3 Maintenance and Repair

Perenio[®] PEIRC01 Cameras do not require special maintenance in the normal course of operation. However, in order to maintain the proper state and stable operation of the device it is recommended to perform the following actions from time to time:

- Clean the Camera lens and the casing from dirt and dust;
- Examine and adjust the Camera's viewing angle;
- Check for updates of the Perenio Smart Mobile App;
- Check for the power adapter condition and replace it in a timely manner;
- Check for the MicroSD Card condition (if any) and replace it in a timely manner;
- Repair mechanical damages to the device (in Service Centers).

Perenio[®] Indoor Motor Camera repairs shall be carried out in Service Centers, because its casing will be opened in the case of any element failure.

In the case of warranty repairs or replacement, the User shall provide the Seller with the sales receipt and the purchased device.

For details on the replacement and repairs of **Perenio[®]** Cameras, please contact your local Company representative or the Tech Support Department at **perenio.com**

4 Warranty Obligations

The warranty period for Cameras shall be **Twenty-four (24) months** from the date of sale to the End User.

The warranty period for components and accessories shall be as follows:

- External chargers, cables and other accessories: Six (6) months from the date of sale to the End Customer.

The Warranty Card shall be deemed valid provided that it is correctly and completely filled in by the Seller. Upon the purchase, the Customer shall check that both the Serial Number and the Model name of the device correspond to those indicated in the Warranty Card.

Incomplete or illegible Warranty Card shall be deemed not valid. In this case, it is recommended to contact the Seller and ask for a duly filled in Warranty Card. It shall be also allowed to provide the original of the sales/cashier's receipt or such other documentary evidence of the fact and the date of sale of the device. The date of sale shall be the date indicated on the sales/cashier's receipt or other relevant document. If the date of sale is not possible to be determined, the start of the warranty period shall be the date of manufacture of the device.

The Manufacturer shall guarantee that all materials, components and assemblies of **Perenio®** devices are free from defects under normal operation within the warranty period. The limited warranty shall be applied to the first End Customer of **Perenio®** devices only and cannot be transferred to a subsequent customer.

For warranty replacement, the device must be returned to the Seller along with its receipt. Warranty obligations for **Perenio®** devices shall be provided in the country of their purchase only.

WARRANTY SERVICE PROCEDURE

In the case of any alleged defect or deficiency of the device detected, the Customer shall contact the Authorized Service Center before the warranty period expiration and provide the following:

1. The device with an alleged defect or deficiency.
2. The Warranty Card filled out in accordance with the applicable legal requirements, or the original of the document confirming the purchase of the device, including clear indication of the name and the address of the Seller, as well as the date when this device was sold.

LIMITATION OF LIABILITY

Perenio[®] devices SHALL NOT BE SUBJECT TO a free warranty service in the case of identification of at least one of the following damages or defects:

- Any damage caused by force majeure, accidents, and willful or careless acts (omissions) of the Customer or third parties;
- Any damage caused by the impact of other objects including but not limited to exposure to moisture, dampness, extreme temperatures or environmental conditions (or jumps in such conditions), corrosion and oxidation, as well as penetration of food or liquid, and the effects of chemicals, animals, insects and byproducts thereof;
- In the event when the device (accessories and/or components) was unsealed (the seal integrity was violated), modified or repaired by any party other than the Authorized Service Center, including repair works using unauthorized spare parts;
- Any defects or damage caused by improper or unintended use of the device, including operation contrary to available manuals;
- Any defects caused by attempts to connect to incompatible software;
- Any defects caused by natural wear and tear of Products, including bags, casings, batteries or Installation and Operation Manuals;
- In the event when the Serial Number (Name Plates), the date of manufacture or the Model name on the device casing was in any way removed, erased, affected, altered or made illegible;
- In the case of violation of operating procedures and conditions, as well as the device installation instructions described in relevant Manuals;
- Cracks, scratches and other defects caused as a result of transportation and/or operation of the device by the Customer or acts of negligence on their part;
- Mechanical damages that occurred after transferal of the device to the Customer including damage caused by sharp objects, bending, squeezing, falling, etc.;
- Any damage caused by non-conformity with the standards of power supply, telecommunication and cable networks or similar external factors.

THE PRESENT LIMITED WARRANTY IS AN EXCLUSIVE AND THE ONLY PROVIDED GUARANTEE THAT SHALL REPLACE ANY OTHER EXPRESS AND IMPLIED GUARANTEES. THE MANUFACTURER SHALL PROVIDE NO GUARANTEES, WHETHER EXPRESS OR IMPLIED, BEYOND THE DESCRIPTION CONTAINED IN THE PRESENT DOCUMENT, INCLUDING THE IMPLIED WARRANTY OF MERCHANTABILITY AND FITNESS FOR A PARTICULAR PURPOSE. THE CUSTOMER MAY USE DEFECTIVE OR INAPPLICABLE DEVICE AT HIS/HER OWN DISCRETION. THE MANUFACTURER SHALL NOT BE RESPONSIBLE FOR DAMAGE TO OTHER PROPERTY BY DEVICE DEFECTS, THE LOSS OF USABILITY OR TIME OR FOR ANY SPECIAL, INCIDENTAL, INDIRECT OR CONSEQUENTIAL DAMAGE OR LOSS INCLUDING BUT NOT LIMITED TO COMMERCIAL

LOSS, LOSS OF PROFITS, LOSS OF CONFIDENTIAL OR OTHER INFORMATION, AS WELL AS DAMAGES CAUSED BY BREAKS IN COMMERCIAL OR PRODUCTION ACTIVITIES DUE TO THE FACT THAT THE DEVICE WAS RECOGNIZED AS FAULTY, DEFECTIVE OR NOT ALLOWED FOR USAGE.

The present limited warranty shall provide the Customer with certain legal rights. The Customer may also have other rights in accordance with the local consumer protection laws that vary from country to country and may not coincide with this limited warranty. For full understanding of the Customer's rights, you shall read local acts.

NOTE. The Manufacturer does not produce equipment for *Vital Tasks*. Vital Task Products shall include life support systems, medical equipment, implantation-related medical devices, commercial transportation, nuclear equipment or systems, and any other fields of application where equipment failures may do harm to a humans' health or cause their deaths, as well as result in a property damage.

5 Storage, Transportation and Disposal of Devices

Perenio[®] Indoor Motor Cameras may be shipped by any kind of covered vehicles (by rail, or road or in sealed heated airplane compartments, etc.) in accordance with the requirements of current regulatory documents applicable to fragile goods sensitive to moisture.

Similar conditions shall apply to the device storage at the Seller's warehouse.

In accordance with the Waste Electrical and Electronic Equipment (WEEE)* regulations, all electrical and electronic products must be collected separately at the end of their service life, and cannot be disposed of together with unsorted household waste.

Parts of worn out devices must be separated and sorted by the material type. In this way, every user can contribute to reuse, recycling and other forms of recovery of waste electrical and electronic equipment. Proper collection, recycling, and disposal of such devices will help avoid potential environmental and health impacts from the harmful substances they contain.

To dispose of the device, it must be returned to the point of sale, or to a local waste collection and recycling company recommended by the state or local authorities. Disposal is carried out in accordance with the applicable laws and regulations of the respective country.

For more details on how to properly dispose of your used device, please contact your device supplier, your waste disposal service or the local authorities responsible for waste disposal.

NOTE. The User must comply with the temperature and humidity conditions of storage and transportation specified in the Table of technical specifications of the present Installation and Operation Manual.

* Waste Electrical and Electronic Equipment, or WEEE, means used electrical or electronic equipment, including all components, assemblies, consumables that are part of the equipment at the time it is taken out of service (including supplied batteries (if any), components containing mercury, etc.).

6 Other Information

Manufacturer

Name	<i>Perenio IoT spol s r.o.</i>
Address	Na Dlouhem 79, Ricany – Jazlovice 251 01, Czech Republic
Contact Info	perenio.com, info@perenio.com

Importing Company

Name	<i>ASBISc Enterprises PLC</i>
Address	43 Kolonakiou Street, Diamond Court, Ayios Athanasios, 4103 Limassol, Cyprus

Quality Claims Acceptance and Warranty Service Company

Name	<i>ASBISc Enterprises PLC</i>
Address	43 Kolonakiou Street, Diamond Court, Ayios Athanasios, 4103 Limassol, Cyprus
Czech Republic	
Name	<i>ASBIS CZ, s.r.o.</i>
Address	Obchodní 103, Čestlice, 25101

Info on Certificates and Declarations

Certificates	Certificate of Conformity #POCE18032802GCT as of March 30, 2018; Certificate of Conformity #POCE18032826BCR as of April 2, 2018
Declarations, Reports	EMC Test Report #POCE18032813SRE as of March 30, 2018; Radio Test Report #POCE18032866WRF as of March 30, 2018; Health Test Reports #POCE18032865URF as of March 30, 2018; LVD Test Report #POCE18032802HRS as of April 8, 2018; ROHS Test Report #POCE18032826BRR as of April 2, 2018

Addresses of Service Centers are available at **perenio.com** in the 'Support' Section.

7 Troubleshooting

Table below shows typical errors and problems that may occur in the process of connection and configuration of video surveillance systems.

Table 6 – Typical Errors and Troubleshooting Methods

Item No	Problem	Possible Reasons	Solution
1	The Camera does not initialize or incidentally reboots	Malfunction of the power adapter or a power supply failure	Replace the power adapter or wait for a stable power supply
2	Slow operation of the Camera or video loss	Camera and/or Internet connection failure	Try to reconnect the Camera or wait until the connection to the network is restored
3	The Camera is offline (Video is unavailable)	Camera and/or Internet connection failure	Try to reconnect the Camera or wait until the connection to the network is restored
4	Error during connection to Camera Wi-Fi	Cannot get the Camera IP Address	Go to Wi-Fi Settings. While in the list of available Wi-Fi Networks, reset the Camera. After the Camera access point is in the list again, click on it to connect. The "Internet may be unavailable" message will appear. Go back to the Perenio Smart App and continue connection to Camera step.

8 Glossary

AUX OUT	An auxiliary output in the device to connect the Mini-Jack of 3.5 mm to
IR Filter	A filter that blocks infrared waves in the daytime and allows you to create the correct image from the point of view of a human perception. At nights, the use of an IR Filter is not required
Location	General term which means a building or a structure in which Perenio® Cameras, Control gateways and/or Sensors are installed
MicroSD	A small-sized electronic memory device that is used for storage of digital information
P2P Camera	The IP Camera which (upon connection to the Internet) automatically sends a request to a remote server. This server then identifies the Camera by its unique ID. To access the Camera and watch the video, the User shall install a special software developed by the IP Camera Manufacturer
Perenio Smart	Software developed by <i>Perenio IoT</i> for remote control of devices from smartphones
PIR Sensor	The passive infrared sensor with a pyroelectric sensing element that responds to changes in heat emission
Preset	A predefined angle of pan/tilt of the Camera to which it will automatically return after a specified period of time if it was changed by the User.
QR Code	The quick response code which represents a matrix barcode containing information about the object to which it is linked
Viewing Angle	The area that falls into the field of viewing of the Camera. The viewing angle depends on the focal length of the Camera lens and the image sensor size
Zigbee	A network protocol designed for secure transmission of data at low speeds, which is recognized for an extremely low power consumption